

NEEDLE ROLLER CAGES FOR GENERAL USAGE



Structure and Features

IKO Needle Roller Cages for General Usage are bearings which display excellent rotational performance. Needle rollers with extremely small dimensional variations in diameter are incorporated and retained in their specially shaped cages with high rigidity and accuracy, which precisely guide the needle rollers.

When combined with shafts and housing bores that are heat treated and accurately ground as raceway surfaces, Needle Roller Cages for General Usage are particularly useful in small spaces.

In addition, since they are lightweight and have high rigidity as well as a large lubricant holding capacity, they can withstand severe operating conditions such as high speed rotation and shock loads, and they are used in a wide range of applications.

Structures of Needle Roller Cages for General Usage

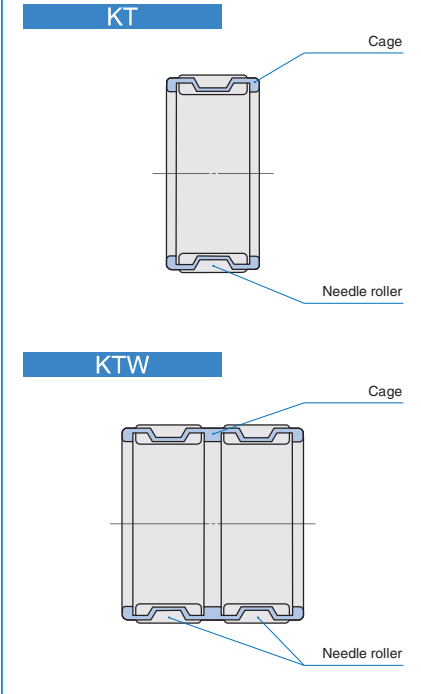

Types

Needle Roller Cages for General Usage are available in two types, with single row needle rollers and double row needle rollers.

For applications such as crank shafts where these bearings are difficult to install, it is also possible to make split type bearings.

If such bearings are required, please contact **IKO**. For Needle Roller Cages for Engine Connecting Rods (KT...EG and KTV...EG), see page C17.

Identification Number

The identification number of Needle Roller Cages for General Usage consists of a model code, dimensions and any supplemental codes. The arrangement examples are shown below.

Examples of identification number

Example 1

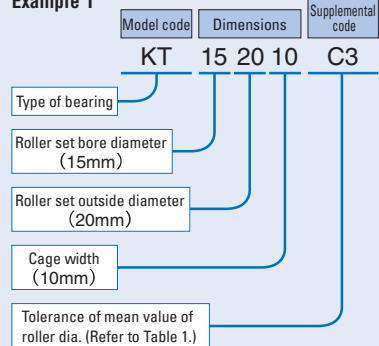

Example 2

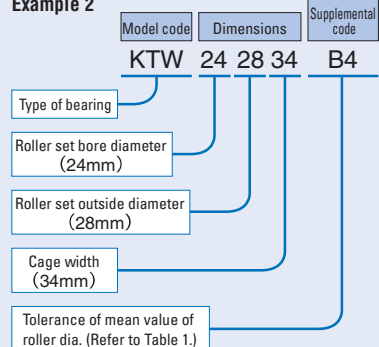

Accuracy

The diameter tolerances of needle rollers of Needle Roller Cages for General Usage are classified by classification symbols shown in Table 1. If a classification symbol is not indicated in an identification number, the classification symbol "C3" is applied.

When two or more bearings are used in tandem arrangement on the same shaft, it is necessary to select bearings of the same classification symbol to obtain an even load distribution.

The tolerance of the cage width B_c is $-0.20 \sim -0.55$ mm.

Table 1 Diameter tolerances of needle rollers unit: μ m

Classification symbol	Tolerance of mean value of needle roller diameter
C 3	0 ~ - 3
B 2	0 ~ - 2
B 4	- 2 ~ - 4
B 6	- 4 ~ - 6
B 8	- 6 ~ - 8
B10	- 8 ~ - 10

Fit

Radial clearances of Needle Roller Cages for General Usage are determined by the dimensional accuracy of the raceways and needle rollers. Table 2 shows the recommended fits for the operating conditions.

Table 2 Recommended fits of shaft to the housing bore diameter G6

Operating conditions	Shaft	
	$F_w \leq 68\text{mm}$	$F_w > 68\text{mm}$
When high operating accuracy is required.	j5	h5
When shock loads and oscillating motions are applied.	j5	h5
For general use	h5	g5
When the temperature is high, or mounting errors are large.	g6	f6

Remark When setting the required radial clearance according to the operating conditions, the clearance can easily be obtained by selecting and matching the tolerances of needle rollers, shaft and housing bore. When variation of the clearance does not create any problems, h6 and G7 are used for shaft and housing bore, respectively.

Specifications of shaft and housing

For the raceways, a surface hardness of $58 \sim 64\text{HRC}$ and a surface roughness $0.2 \mu\text{m}R_a$ or less are desirable. However, when the operating conditions are not severe, a surface roughness $0.8 \mu\text{m}R_a$ or less can be used.

When the surface hardness is low, it is necessary to correct the load rating by the hardness factor specified on page A20.

Operating temperature range

For synthetic resin cages, "N" is added at the end of the identification number. The operating temperature range for Needle Roller Cages for General Usage is $-20 \text{ }^\circ\text{C} \sim +120 \text{ }^\circ\text{C}$. However, the maximum allowable temperature for synthetic resin cages is $+110 \text{ }^\circ\text{C}$, and when they are continuously operated, it is $+100 \text{ }^\circ\text{C}$.

Mounting

The dimensions related to mounting of Needle Roller Cages for General Usage are shown in Figs. 1 and 2.

When mounting Needle Roller Cages for General Usage, they are axially positioned by using, for example, Cir-clips for shaft and housing bore (WR and AR on page L17) as shown in Figs. 3, 4 and 5.

For high rotational speed applications, a heat treated and ground spacer is positioned between the cage and the cir-clip as shown in Fig. 5 so that the cage does not make direct contact with the cir-clip. In this case, the cir-clip is normally mounted on the non-rotating side.

Fig. 3 shows a mounting example in the case of outer ring rotation, and Figs. 4 and 5 show examples in the case of inner ring rotation.

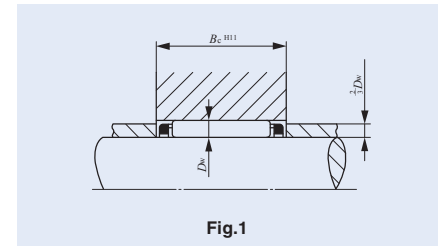

Fig.1

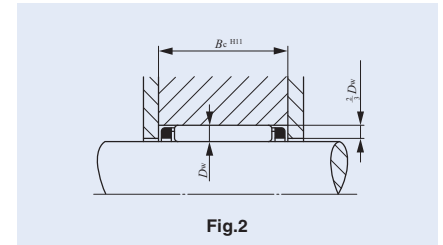

Fig.2

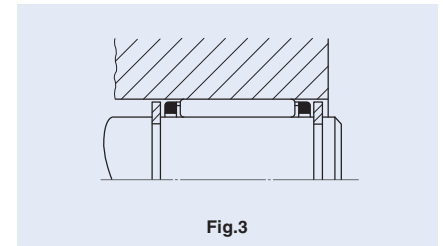

Fig.3

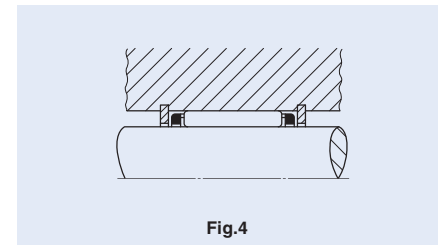

Fig.4

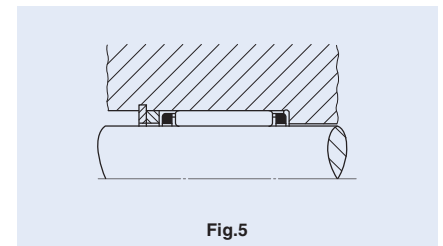
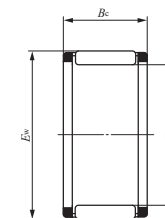

Fig.5

NEEDLE ROLLER CAGES FOR GENERAL USAGE



KT

Shaft dia. 3 – 14mm

Shaft dia. mm	Identification number	Mass (Ref.) g	Boundary dimensions mm			Basic dynamic load rating C N	Basic static load rating C ₀ N	Allowable rotational speed ⁽¹⁾ rpm
			F _w	E _w	B _c			
3	KT 367N	0.39	3	6	7	1 480	990	140 000
4	KT 477N	0.47	4	7	7	1 800	1 300	100 000
5	KT 587N	0.53	5	8	7	2 070	1 600	85 000
	KT 588N	0.66	5	8	8	2 420	1 950	85 000
6	KT 697N	0.63	6	9	7	2 310	1 900	75 000
	KT 698N	0.75	6	9	8	2 700	2 320	75 000
	KT 6910	1.45	6	9	10	3 010	2 660	75 000
	KT 61013	2.7	6	10	13	4 410	3 720	75 000
7	KT 7108N	0.86	7	10	8	2 960	2 690	65 000
	KT 71010	1.69	7	10	10	3 340	3 130	65 000
8	KT 8118N	0.96	8	11	8	3 190	3 060	60 000
	KT 81110	1.9	8	11	10	3 630	3 600	60 000
	KT 81113	2.5	8	11	13	4 500	4 750	60 000
	KT 8128	2.1	8	12	8	3 630	3 040	60 000
	KT 81211	3	8	12	11	4 630	4 170	60 000
9	KT 91210	2.1	9	12	10	3 900	4 070	55 000
	KT 91213	2.8	9	12	13	4 840	5 370	55 000
10	KT 10138	1.9	10	13	8	3 370	3 470	50 000
	KT 101310	2.3	10	13	10	4 160	4 550	50 000
	KT 101313	3	10	13	13	5 160	6 000	50 000
	KT 101410	3.2	10	14	10	4 900	4 680	50 000
	KT 101412	3.8	10	14	12	5 940	6 000	50 000
	KT 101413	4.2	10	14	13	6 100	6 200	50 000
KT 101415	4.8	10	14	15	7 080	7 520	50 000	
11	KT 111410	2.5	11	14	10	4 400	5 020	45 000

Note⁽¹⁾ Allowable rotational speed applies to oil lubrication. For grease lubrication, a maximum of 50% of this value is allowable.
Remark For synthetic resin cages, "N" is added at the end of the identification number.

Shaft dia. mm	Identification number	Mass (Ref.) g	Boundary dimensions mm			Basic dynamic load rating C N	Basic static load rating C ₀ N	Allowable rotational speed ⁽¹⁾ rpm
			F _w	E _w	B _c			
12	KT 12158	2.2	12	15	8	3 750	4 200	40 000
	KT 121510	2.7	12	15	10	4 620	5 490	40 000
	KT 121512	3.2	12	15	12	5 590	7 020	40 000
	KT 121513	3.6	12	15	13	5 730	7 250	40 000
	KT 121514	3.8	12	15	14	6 200	8 010	40 000
	KT 121610	4	12	16	10	5 650	5 890	40 000
	KT 121613	5.2	12	16	13	7 020	7 800	40 000
	KT 121618	7	12	16	18	9 790	11 900	40 000
	KT 121710	5.1	12	17	10	6 170	5 740	40 000
	KT 121812	7.8	12	18	12	9 030	8 460	40 000
	KT 121820	13.2	12	18	20	13 700	14 400	40 000
13	KT 131710	4.3	13	17	10	5 990	6 500	40 000
	KT 131815	8.2	13	18	15	9 660	10 400	40 000
	KT 131816	8.7	13	18	16	10 300	11 400	40 000
14	KT 14188	3.7	14	18	8	5 110	5 410	35 000
	KT 141810	4.6	14	18	10	6 320	7 110	35 000
	KT 141811	5.2	14	18	11	6 520	7 410	35 000
	KT 141813	6	14	18	13	7 860	9 410	35 000
	KT 141816	7.3	14	18	16	9 750	12 400	35 000
	KT 141910	5.9	14	19	10	7 130	7 180	35 000
	KT 141916	9.4	14	19	16	11 100	12 600	35 000
	KT 141918	10.5	14	19	18	12 400	14 700	35 000
KT 142012	8.7	14	20	12	9 790	9 680	35 000	
KT 142017	12.4	14	20	17	13 300	14 400	35 000	



NEEDLE ROLLER CAGES FOR GENERAL USAGE

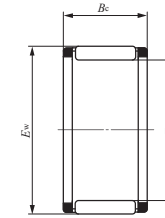

KT

Shaft dia. 15 – 18mm

Shaft dia. mm	Identification number	Mass (Ref.) g	Boundary dimensions mm			Basic dynamic load rating C N	Basic static load rating C ₀ N	Allowable rotational speed ⁽¹⁾ rpm	
			F _w	E _w	B _c				
15	KT 15199	4.4	15	19	9	6 120	6 950	35 000	
	KT 151910	4.9	15	19	10	6 630	7 720	35 000	
	KT 151911	5.5	15	19	11	6 850	8 040	35 000	
	KT 151913	6.4	15	19	13	8 250	10 200	35 000	
	KT 151917	8.2	15	19	17	10 900	14 600	35 000	
	KT 151918	8.7	15	19	18	11 500	15 600	35 000	
	KT 152010	6.3	15	20	10	7 580	7 920	35 000	
	KT 152115	11.9	15	21	15	12 600	13 500	35 000	
	16	KT 162010	5.2	16	20	10	6 930	8 330	30 000
KT 162013		6.8	16	20	13	8 620	11 000	30 000	
KT 162016		8.3	16	20	16	10 700	14 600	30 000	
KT 162017		8.7	16	20	17	11 400	15 700	30 000	
KT 162118		12	16	21	18	14 000	17 700	30 000	
KT 162120		13.6	16	21	20	14 700	18 900	30 000	
KT 162125		16.6	16	21	25	18 300	25 100	30 000	
KT 162212		9.7	16	22	12	10 500	10 900	30 000	
KT 162214		11.5	16	22	14	11 600	12 500	30 000	
KT 162217		13.8	16	22	17	14 200	16 100	30 000	
KT 162220		16.5	16	22	20	15 900	18 600	30 000	
KT 162420		23.5	16	24	20	18 500	19 000	30 000	
17		KT 172110	5.5	17	21	10	7 220	8 950	30 000
		KT 172113	7.2	17	21	13	8 980	11 800	30 000
	KT 172115	8.2	17	21	15	10 400	14 400	30 000	
	KT 172117	9.3	17	21	17	11 800	16 900	30 000	
	KT 172220	14	17	22	20	15 500	20 500	30 000	
	KT 172311	9.6	17	23	11	10 100	10 500	30 000	
	KT 172315	13.1	17	23	15	13 300	15 100	30 000	
	KT 172418	18.6	17	24	18	16 500	18 000	30 000	

Note⁽¹⁾ Allowable rotational speed applies to oil lubrication. For grease lubrication, a maximum of 50% of this value is allowable.

Shaft dia. mm	Identification number	Mass (Ref.) g	Boundary dimensions mm			Basic dynamic load rating C N	Basic static load rating C ₀ N	Allowable rotational speed ⁽¹⁾ rpm
			F _w	E _w	B _c			
18	KT 18228	4.7	18	22	8	6 060	7 270	30 000
	KT 182210	5.8	18	22	10	7 500	9 560	30 000
	KT 182213	7.6	18	22	13	9 330	12 700	30 000
	KT 182216	9.2	18	22	16	11 600	16 700	30 000
	KT 182412	11	18	24	12	11 800	13 100	30 000
	KT 182416	14.8	18	24	16	15 100	17 900	30 000
	KT 182417	15.7	18	24	17	16 000	19 400	30 000
	KT 182420	18.7	18	24	20	17 900	22 400	30 000
	KT 182517	18.8	18	25	17	16 700	18 600	30 000
	KT 182519	21	18	25	19	18 700	21 400	30 000
	KT 182522	24.5	18	25	22	20 600	24 200	30 000
	KT 182614	18.1	18	26	14	14 600	14 400	30 000
	KT 182620	26	18	26	20	20 000	21 600	30 000



NEEDLE ROLLER CAGES FOR GENERAL USAGE

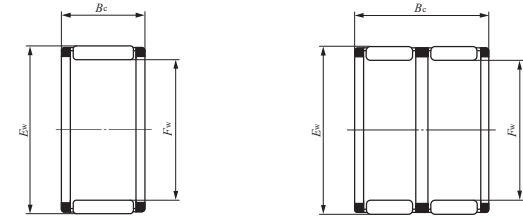

KT

KTW

Shaft dia. 20 – 24mm

Shaft dia. mm	Identification number	Mass (Ref.) g	Boundary dimensions mm			Basic dynamic load rating C N	Basic static load rating C ₀ N	Allowable rotational speed ⁽¹⁾ rpm
			F _w	E _w	B _c			
20	KT 202410	6.3	20	24	10	7 710	10 200	25 000
	KT 202413	8.3	20	24	13	9 590	13 500	25 000
	KT 202417	10.6	20	24	17	12 600	19 300	25 000
	KTW 202422	14.6	20	24	22	13 700	21 300	25 000
	KT 202525	19.7	20	25	25	19 900	29 800	25 000
	KTW 202531.6	26.5	20	25	31.6	21 700	33 200	25 000
	KTW 202540	32.5	20	25	40	27 500	44 900	25 000
	KT 202611	11.1	20	26	11	11 200	12 500	25 000
	KT 202612	12	20	26	12	12 400	14 300	25 000
	KT 202614	14.2	20	26	14	13 700	16 400	25 000
	KT 202617	17	20	26	17	16 800	21 200	25 000
	KT 202620	20.5	20	26	20	18 700	24 400	25 000
	KT 202624	24	20	26	24	22 500	30 900	25 000
	KT 202627	26.5	20	26	27	26 000	37 300	25 000
	KT 202814	20	20	28	14	15 700	16 100	25 000
	KT 202820	29	20	28	20	21 500	24 200	25 000
KT 203225	49.5	20	32	25	30 800	30 500	25 000	
21	KT 212610	8.5	21	26	10	9 090	11 000	25 000
	KT 212611	9.6	21	26	11	9 390	11 500	25 000

Note⁽¹⁾ Allowable rotational speed applies to oil lubrication. For grease lubrication, a maximum of 50% of this value is allowable.

Shaft dia. mm	Identification number	Mass (Ref.) g	Boundary dimensions mm			Basic dynamic load rating C N	Basic static load rating C ₀ N	Allowable rotational speed ⁽¹⁾ rpm
			F _w	E _w	B _c			
22	KT 222610	6.9	22	26	10	8 220	11 500	25 000
	KT 222613	9.1	22	26	13	10 200	15 200	25 000
	KT 222617	11.6	22	26	17	13 500	21 600	25 000
	KTW 222625	17.7	22	26	25	17 100	29 400	25 000
	KT 222720	17.9	22	27	20	17 400	25 700	25 000
	KT 222726	22.5	22	27	26	22 500	35 800	25 000
	KT 222817	18.4	22	28	17	17 500	23 000	25 000
	KT 222912	16.1	22	29	12	12 900	14 000	25 000
	KT 222916	21	22	29	16	17 600	20 900	25 000
	KT 222917	22.5	22	29	17	18 700	22 600	25 000
	KT 222918	23.5	22	29	18	19 800	24 400	25 000
	KT 222920	26.5	22	29	20	20 900	26 100	25 000
	KT 223015	23.5	22	30	15	17 900	19 700	25 000
	KT 223230	52.5	22	32	30	36 400	42 700	25 000
KT 223232	56	22	32	32	38 800	46 300	25 000	
23	KT 232824	22	23	28	24	21 600	34 500	20 000
	KT 232913	15.1	23	29	13	13 800	17 200	20 000
	KT 233015	21	23	30	15	17 300	20 800	20 000
	KT 233016	22	23	30	16	18 600	22 600	20 000
24	KT 242813	9.9	24	28	13	10 800	16 800	20 000
	KT 242816	12	24	28	16	13 400	22 200	20 000
	KTW 242834	27	24	28	34	21 600	40 700	20 000
	KT 242913	12.8	24	29	13	12 700	17 600	20 000
	KT 243020	23.5	24	30	20	20 300	28 500	20 000



NEEDLE ROLLER CAGES FOR GENERAL USAGE

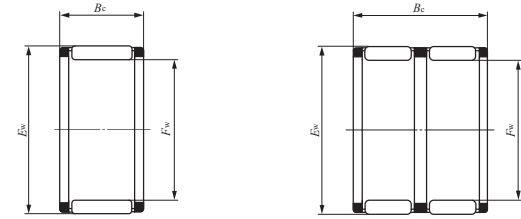

KT

KTW

Shaft dia. 25 – 32mm

Shaft dia. mm	Identification number	Mass (Ref.) g	Boundary dimensions mm			Basic dynamic load rating C N	Basic static load rating C ₀ N	Allowable rotational speed ⁽¹⁾ rpm
			F _w	E _w	B _c			
25	KT 252910	7.9	25	29	10	8 940	13 300	20 000
	KT 252913	10.3	25	29	13	11 100	17 600	20 000
	KT 253013	13.3	25	30	13	13 100	18 600	20 000
	KT 253016	16.2	25	30	16	16 300	24 600	20 000
	KT 253017	17.1	25	30	17	17 300	26 600	20 000
	KT 253020	20	25	30	20	18 600	29 100	20 000
	KT 253113	16.2	25	31	13	14 300	18 400	20 000
	KT 253116	19.6	25	31	16	17 800	24 400	20 000
	KT 253117	20.5	25	31	17	19 000	26 500	20 000
	KT 253120	25	25	31	20	21 200	30 500	20 000
	KT 253216	23.5	25	32	16	19 400	24 500	20 000
	KT 253224	35	25	32	24	27 700	38 700	20 000
	KT 253515	33	25	35	15	22 600	23 800	20 000
	KT 253525	48	25	35	25	32 500	37 900	20 000
KT 253530	58	25	35	30	39 100	48 000	20 000	
26	KT 263013	10.7	26	30	13	11 400	18 400	19 000
	KT 263832	79.5	26	38	32	47 200	55 300	19 000
28	KT 283313	14.8	28	33	13	13 800	20 700	18 000
	KT 283317	18.9	28	33	17	18 300	29 500	18 000
	KT 283327	29	28	33	27	26 300	47 300	18 000
	KT 283417	23	28	34	17	20 300	29 900	18 000
	KT 283516	26	28	35	16	20 100	26 500	18 000
	KT 283528	44.5	28	35	28	33 200	50 600	18 000
	KT 283620	38.5	28	36	20	26 500	34 700	18 000
	KT 284138	110	28	41	38	58 700	71 100	18 000

Note⁽¹⁾ Allowable rotational speed applies to oil lubrication. For grease lubrication, a maximum of 50% of this value is allowable.

Shaft dia. mm	Identification number	Mass (Ref.) g	Boundary dimensions mm			Basic dynamic load rating C N	Basic static load rating C ₀ N	Allowable rotational speed ⁽¹⁾ rpm
			F _w	E _w	B _c			
30	KT 303513	15.6	30	35	13	14 100	21 700	17 000
	KT 303516	18.9	30	35	16	17 500	28 700	17 000
	KT 303517	20	30	35	17	18 700	31 100	17 000
	KT 303524	28.5	30	35	24	24 900	45 100	17 000
	KT 303527	31.5	30	35	27	27 900	52 100	17 000
	KT 303613	19.1	30	36	13	15 800	22 100	17 000
	KT 303620	29.5	30	36	20	23 300	36 500	17 000
	KT 303630	41.5	30	36	30	33 200	57 500	17 000
	KT 303715	26	30	37	15	19 500	26 000	17 000
	KT 303716	27.5	30	37	16	20 800	28 400	17 000
	KT 303720	35	30	37	20	24 700	35 400	17 000
	KT 303723	39.5	30	37	23	28 500	42 500	17 000
	KT 303818	36.5	30	38	18	26 200	34 800	17 000
	KT 303824	48.5	30	38	24	33 200	47 200	17 000
	KT 304232	93	30	42	32	54 000	68 100	17 000
	KTW 304237	117	30	42	37	55 900	71 300	17 000
32	KT 323713	16.7	32	37	13	14 900	23 700	16 000
	KT 323717	21.5	32	37	17	19 600	33 900	16 000
	KT 323723	28.5	32	37	23	24 400	44 800	16 000
	KT 323813	20.5	32	38	13	16 800	24 400	16 000
	KT 323820	31.5	32	38	20	24 800	40 300	16 000
	KT 323916	29	32	39	16	21 600	30 200	16 000
	KT 323920	37	32	39	20	25 600	37 700	16 000
	KT 324519	63.5	32	45	19	33 700	35 900	16 000
	KT 324525	84.5	32	45	25	45 600	53 000	16 000
	KT 324532	109	32	45	32	58 500	73 000	16 000
	KT 324550	162	32	45	50	81 500	111 000	16 000



NEEDLE ROLLER CAGES FOR GENERAL USAGE

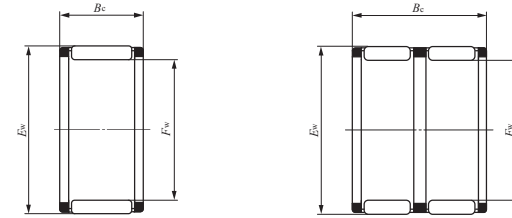

KT

KTW

Shaft dia. 35 – 52mm

Shaft dia. mm	Identification number	Mass (Ref.) g	Boundary dimensions mm			Basic dynamic load rating C N	Basic static load rating C ₀ N	Allowable rotational speed ⁽¹⁾ rpm
			F _w	E _w	B _c			
35	KT 354013	18.1	35	40	13	15 500	25 800	14 000
	KT 354017	23	35	40	17	20 500	36 900	14 000
	KT 354026	34.5	35	40	26	28 700	56 800	14 000
	KT 354113	22.5	35	41	13	17 700	26 800	14 000
	KT 354216	32	35	42	16	23 100	33 900	14 000
	KT 354218	35.5	35	42	18	26 000	39 500	14 000
	KT 354220	40.5	35	42	20	27 400	42 300	14 000
	KT 354230	59	35	42	30	40 600	70 300	14 000
	KT 354525	68.5	35	45	25	42 100	57 900	14 000
36	KT 364216	27.5	36	42	16	21 900	35 700	14 000
38	KT 384417	30.5	38	44	17	23 800	40 400	13 000
	KT 384620	50	38	46	20	30 500	45 400	13 000
	KT 384632	80	38	46	32	45 400	75 700	13 000
40	KT 404513	20.5	40	45	13	16 800	29 800	12 000
	KT 404517	26.5	40	45	17	22 200	42 700	12 000
	KT 404527	41	40	45	27	32 400	69 200	12 000
	KT 404817	44	40	48	17	28 100	41 600	12 000
	KT 404820	52.5	40	48	20	31 400	48 000	12 000
	KT 404825	64.5	40	48	25	39 300	64 000	12 000
	KT 404834	87.5	40	48	34	51 100	89 600	12 000
	KT 405015	48.5	40	50	15	28 200	35 900	12 000
	KT 405017	56.5	40	50	17	30 200	39 200	12 000
	KT 405020	61	40	50	20	35 700	48 600	12 000
	KTW 405238	158	40	52	38	65 000	93 000	12 000
	KT 405432	144	40	54	32	66 800	87 200	12 000
	KT 405450	215	40	54	50	93 600	134 000	12 000
	KT 405463	270	40	54	63	115 000	175 000	12 000

Note⁽¹⁾ Allowable rotational speed applies to oil lubrication. For grease lubrication, a maximum of 50% of this value is allowable.

Shaft dia. mm	Identification number	Mass (Ref.) g	Boundary dimensions mm			Basic dynamic load rating C N	Basic static load rating C ₀ N	Allowable rotational speed ⁽¹⁾ rpm
			F _w	E _w	B _c			
41	KT 414835	78.5	41	48	35	47 800	90 800	12 000
42	KT 424717	27.5	42	47	17	22 500	44 200	12 000
	KT 424815	30	42	48	15	22 400	38 600	12 000
	KT 424816	32	42	48	16	24 000	42 100	12 000
	KT 425020	55	42	50	20	32 400	50 600	12 000
	KT 425030	80.5	42	50	30	48 200	84 400	12 000
45	KT 455017	29.5	45	50	17	23 300	47 100	11 000
	KT 455027	46	45	50	27	34 800	79 000	11 000
	KT 455320	58	45	53	20	33 200	53 300	11 000
	KT 455325	71.5	45	53	25	41 500	71 100	11 000
	KT 455330	86	45	53	30	47 800	85 300	11 000
45	KT 455335	101	45	53	35	53 900	99 500	11 000
	KT 455527	90.5	45	55	27	50 300	78 200	11 000
48	KT 485320	37	48	53	20	26 800	57 600	10 000
	KT 485420	46	48	54	20	30 600	60 400	10 000
50	KT 505520	38.5	50	55	20	27 100	59 300	10 000
	KT 505527	50.5	50	55	27	35 600	84 100	10 000
	KT 505820	65	50	58	20	35 900	61 100	10 000
	KT 505825	80	50	58	25	44 900	81 500	10 000
	KT 505830	96.5	50	58	30	51 700	97 800	10 000
50	KT 505835	113	50	58	35	58 300	114 000	10 000
	52	KT 525817	41	52	58	17	28 300	56 000
KT 526024		80	52	60	24	44 000	80 800	9 500





Shaft dia. 55 – 100mm

Shaft dia. mm	Identification number	Mass (Ref.) g	Boundary dimensions mm			Basic dynamic load rating C N	Basic static load rating C ₀ N	Allowable rotational speed ⁽¹⁾ rpm
			F _w	E _w	B _c			
55	KT 556020	42.5	55	60	20	28 600	66 000	9 000
	KT 556027	55.5	55	60	27	37 600	93 900	9 000
	KT 556120	52	55	61	20	32 600	68 500	9 000
	KT 556315	52.5	55	63	15	29 400	48 700	9 000
	KT 556320	71	55	63	20	37 400	66 400	9 000
	KT 556325	87	55	63	25	46 800	88 600	9 000
58	KT 586320	44.5	58	63	20	29 300	69 400	8 500
	KT 586420	54.5	58	64	20	33 600	72 500	8 500
60	KT 606520	45.5	60	65	20	29 700	71 100	8 500
	KT 606820	76.5	60	68	20	38 900	71 700	8 500
	KT 606825	94	60	68	25	48 600	95 600	8 500
	KT 606827	101	60	68	27	52 400	105 000	8 500
	KT 607236	205	60	72	36	86 700	152 000	8 500
63	KT 637120	79.5	63	71	20	39 500	74 400	8 000
65	KT 657320	83.5	65	73	20	41 200	79 600	7 500
	KT 657330	124	65	73	30	59 300	127 000	7 500
68	KT 687620	86.5	68	76	20	41 800	82 200	7 500
70	KT 707820	89	70	78	20	42 500	84 900	7 000
	KT 707830	132	70	78	30	61 200	136 000	7 000
72	KT 728020	91.5	72	80	20	43 200	87 500	7 000
75	KT 758320	94.5	75	83	20	43 800	90 200	6 500
	KT 758325	116	75	83	25	54 800	120 000	6 500
	KT 758330	141	75	83	30	63 100	144 000	6 500
	KT 758335	164	75	83	35	71 200	168 000	6 500

Note⁽¹⁾ Allowable rotational speed applies to oil lubrication. For grease lubrication, a maximum of 50% of this value is allowable.

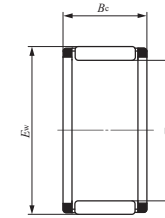

KT

Shaft dia. mm	Identification number	Mass (Ref.) g	Boundary dimensions mm			Basic dynamic load rating C N	Basic static load rating C ₀ N	Allowable rotational speed ⁽¹⁾ rpm
			F _w	E _w	B _c			
80	KT 808822	110	80	88	22	49 700	108 000	6 000
	KT 808825	123	80	88	25	56 400	127 000	6 000
	KT 808830	149	80	88	30	65 000	153 000	6 000
85	KT 859112	44.5	85	91	12	25 200	56 700	6 000
	KT 859325	130	85	93	25	57 800	134 000	6 000
	KT 859330	157	85	93	30	66 600	161 000	6 000
90	KT 909825	138	90	98	25	60 400	145 000	5 500
	KT 909830	167	90	98	30	69 600	174 000	5 500
95	KT 9510330	175	95	103	30	70 900	182 000	5 500
100	KT 10010830	184	100	108	30	72 500	191 000	4 500



NEEDLE ROLLER CAGES FOR ENGINE CONNECTING RODS

- Needle Roller Cages for Big End
- Needle Roller Cages for Small End



Structure and Features

IKO Needle Roller Cages for Engine Connecting Rods are bearings for use in engine connecting rods. These bearings have superior performance proven in high performance engines of racing motor cycles, and are widely used in small motor vehicles, motor cycles, outboard marines, snow mobiles, high-speed compressors, etc. and also in general-purpose engines. Bearings for engine connecting rods are used under extremely severe and complex operating conditions such as heavy shock loads, high speeds, high temperatures and stringent lubrication. Needle Roller Cages for Engine Connecting Rods are lightweight, and have high load ratings and high rigidity as well as superior wear resistance to withstand these severe conditions.

Types

In Needle Roller Cages for Engine Connecting Rods, the types shown in Table 1 are available.

Table 1 Types

Type	For big end	For small end
Model code	KT...EG	KTV...EG

Structures of Needle Roller Cages for Engine Connecting Rods

KT...EG

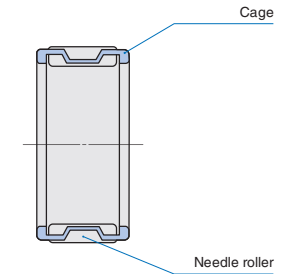

KTV...EG

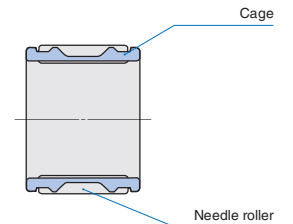

C
KT...EG
KTV...EG

Needle Roller Cages for Big End KT...EG

These roller cages are subjected to acceleration and deceleration during their rotating and epicyclic motion due to crank shaft rotation. To withstand such conditions, they are made of a special alloy and are lightweight with high rigidity.

They are guided on their outer periphery surface with superior lubricating properties.

For the purpose of using them under severe conditions such as high rotational speed and stringent lubrication, bearings plated with non-ferrous metals are also available on request.

High-load capacity and high-rigidity cages to be used for racing motor cycles (See the photo below.), split needle cages for solid (one-piece) type crank-shafts and other special specification cages of various types are also available. Please consult **IKO** when required.



Needle Roller Cages for Small End KTV...EG

These roller cages oscillates at high speeds within a limited loading zone under heavy shock loads. Thus, these cages are designed to be lightweight and have high rigidity with a well-balanced structure. In these cages, a number of needle rollers having a small diameter are incorporated to reduce the rolling contact stress in the loading zone.

Needle Roller Cages for Small End are classified into two types, the outer surface guide type and the inner surface guide type. This classification is shown in the table of dimensions.

In the outer surface guide type, the cage is guided by the sliding contact between the inner surface of the connecting rod and the outer surface of the cage.

In the inner surface guide type, the cage is guided by the sliding contact between the outer surface of the pin and the inner surface of the cage.

Identification Number

The identification number of Needle Roller Cages for Engine Connecting Rods consists of a model code, dimensions and any supplemental codes as shown below.

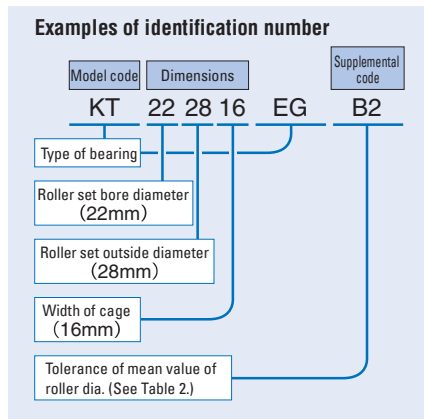

Accuracy

The diameter tolerances of needle rollers of Needle Roller Cages for Engine Connecting Rods are classified as shown in Table 2. When the classification symbol is not indicated in the identification number, the classification symbol "B2" is applied.

The tolerance of the cage width B_c is $-0.2 \sim -0.4$ mm. But cages with marks in the B_c column in the dimension tables are manufactured with the following width tolerances.

- : $0 \sim -0.2$ mm
- : $-0.1 \sim -0.3$ mm

Table 2 Tolerances of needle roller diameter unit: μ m

Class	Classification symbol ⁽¹⁾	Tolerance of mean value of roller dia. ⁽²⁾
Standard	B 2	$0 \sim -2$
	B 4	$-2 \sim -4$
Semi-standard	B 6	$-4 \sim -6$
	B 8	$-6 \sim -8$
	B10	$-8 \sim -10$

Notes⁽¹⁾ The classification symbol is indicated at the end of the identification number.

⁽²⁾ Tolerances for circularity are based on JIS B 1506 (Rolling bearings - Rollers).

Clearance

Radial internal clearances are selected according to the type of engine and the operating conditions (rotational speed, load, lubricating conditions, etc.). If a bearing is used with an inadequate clearance, bearing troubles such as seizure, early flaking and noise increase may occur, leading to an engine failure. Therefore, it is necessary to select the clearance carefully according to test results and experience.

Recommended radial internal clearances are shown in Table 3. When operating at high speeds, it is recommended to select the upper limit of the clearance.

Fit

To obtain the recommended clearance shown in Table 3, it is general practice to match a connecting rod, crank pin or piston pin and needle roller cage of suitable tolerances for assembly.

Precautions for Use

When designing a connecting rod, crank pin and piston pin, the following precautions should be taken, because the raceways are subjected to loads under extremely severe conditions.

1 Material

It is recommended to use carburizing steel because the raceways are subjected to fluctuating loads with frequent and heavy shock loads. Generally, chromium molybdenum steel is used. Nickel chromium molybdenum steel is also used.

2 Hardness

The recommended surface hardness of the raceway is 697~800HV (60~64HRC). While the effective hardening depth differs depending on the applications, the general value is 0.6~1.2 mm.

3 Surface roughness

To minimize initial wear and to extend life, it is recommended that the surface roughness of the crank pin and piston pin be $0.1 \mu m R_a$ or less, and the surface roughness of the connecting rod large end and small end bores be $0.2 \mu m R_a$ or less.

4 Accuracy

Circularity and cylindricity of connecting rod, piston pin and crank pin are as shown in Table 4.

5 Parallelism and torsional accuracy of connecting rod bores

$L \pm 0.02$ mm and $E \pm 0.02$ mm shown in Fig. 1 indicate the parallelism and torsional accuracy between the big end and small end bores of the connecting rod, respectively. The tolerance range is 0.04 mm or less per 100 mm in case of a general-purpose engine and 0.02 mm or less for a high-speed engine such as a racing motorcycle engine. When these accuracy conditions are not satisfied, the axial forces on the needle roller cage and connecting rod will increase, directly leading to a failure such as seizure. Careful consideration is required.

Table 3 Recommended radial internal clearance unit: μ m

Shaft dia. mm		Big end	Small end
Over	Incl.		
—	18	$(d_p - 6) \sim d_p$	3 ~ 15
18	30	$(d_p - 8) \sim d_p$	
30	40	$(d_p - 12) \sim d_p$	

Remark d_p is obtained using the following formula for roller pitch circle diameter in millimeters, and changing the unit from millimeters to micrometers.

$$\text{Roller pitch circle dia.} = \frac{F_w + E_w}{2}$$

Example KT 222814 EG for big end
Recommended clearance is; 17 ~ 25 μ m

Table 4 Accuracy of connecting rod, piston pin and crank pin unit: μ m

Range of dia. mm		Crank pin diameter d_1 Piston pin diameter d_2		Big end bore D_1 Small end bore D_2	
Over	Incl.	Circularity MAX.	Cylindricity MAX.	Circularity MAX.	Cylindricity MAX.
—	18	1	2	2	3
18	30	2	3	3	4
30	40	3	4	4	5

Remark Refer to Fig.1 for the dimension symbols.

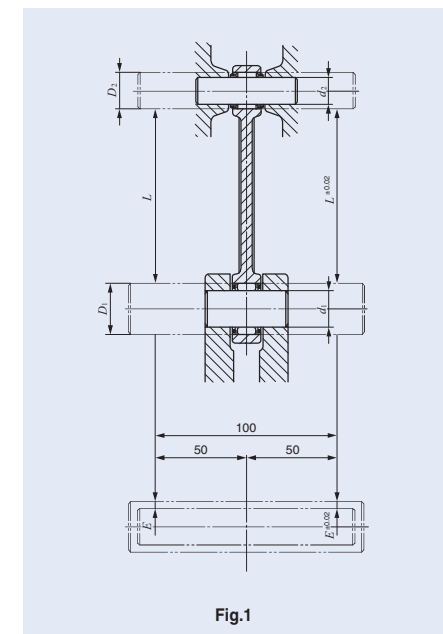

NEEDLE ROLLER CAGES FOR ENGINE CONNECTING RODS

Needle Roller Cages for Big End



KT ... EG

Shaft dia. 8 – 32mm

Shaft dia. mm	Identification number	Mass (Ref.) g	Boundary dimensions mm			Basic dynamic load rating C N	Basic static load rating C ₀ N
			F _w	E _w	B _c		
8	KT 8128 EG	2.1	8	12	8	3 280	2 660
10	KT 101410 EG	3.2	10	14	10	4 900	4 680
12	KT 121610 EG	3.8	12	16	10	5 650	5 890
	KT 121710 EG	5.3	12	17	10	6 670	6 380
14	KT 14199.7 EG	5.7	14	19	9.7	6 120	5 880
	KT 141910 EG	5.7	14	19	10	6 640	6 530
15	KT 15199 EG	4.2	15	19	9	5 790	6 460
	KT 152010 EG	6.1	15	20	10	7 100	7 260
16	KT 162211.5 EG	9.5	16	22	■11.5	9 550	9 660
	KT 162212 EG	9.7	16	22	12	10 500	10 900
18	KT 182210 EG	5.7	18	22	10	7 500	9 560
	KT 182411.6 EG	11	18	24	■11.6	10 600	11 500
	KT 182412 EG	11	18	24	12	11 800	13 100
20	KT 202612 EG	12	20	26	12	12 400	14 300
	KT 202614 EG	13.8	20	26	14	13 000	15 200
	KT 202814 EG	20	20	28	●14	15 700	16 100
22	KT 222814 EG	14.9	22	28	14	13 600	16 600
	KT 222816 EG	17.5	22	28	16	15 700	19 800
	KT 222912 EG	15.2	22	29	12	12 900	14 000
	KT 223215 EG	30	22	32	15	21 300	21 500
23	KT 232913 EG	14.9	23	29	13	12 800	15 600
24	KT 243015 EG	17.9	24	30	15	14 200	18 000
	KT 243016 EG	18.2	24	30	16	16 300	21 500
	KT 243120 EG	28	24	31	20	20 800	26 400
30	KT 303818 EG	35.5	30	38	18	24 900	32 600
32	KT 324220 EG	54	32	42	20	31 900	39 400

Needle Roller Cages for Small End



KTV ... EG

Shaft dia. 9 – 18mm

Shaft dia. mm	Identification number	Mass (Ref.) g	Boundary dimensions mm			Basic dynamic load rating C N	Basic static load rating C ₀ N	Cage guide type
			F _w	E _w	B _c			
9	KTV 91211.5 EG	2.8	9	12	●11.5	3 900	4 070	Outer surface guide
	KTV 91214 EG	3.5	9	12	14	4 440	4 810	Inner surface guide
10	KTV 101316 EG	4.5	10	13	16	4 400	4 880	Inner surface guide
	KTV 101410 EG	3.8	10	14	10	4 520	4 220	Inner surface guide
	KTV 101411 EG	4.1	10	14	11	5 060	4 880	Outer surface guide
	KTV 101412.5 EG	4.8	10	14	●12.5	5 590	5 540	Inner surface guide
10.5	KTV 10.51415 EG	5.1	10.5	14	15	5 710	6 270	Outer surface guide
12	KTV 121514.3 EG	4.3	12	15	●14.3	5 840	7 390	Outer surface guide
	KTV 121613 EG	5.6	12	16	13	7 020	7 800	Outer surface guide
	KTV 121615.5 EG	6.8	12	16	●15.5	7 600	8 600	Outer surface guide
14	KTV 141812 EG	6	14	18	12	6 780	7 760	Inner surface guide
	KTV 141816.5 EG	8.2	14	18	16.5	9 180	11 500	Outer surface guide
	KTV 141822 EG	10.8	14	18	●22	9 950	12 600	Inner surface guide
16	KTV 162019 EG	10.6	16	20	19	10 800	14 600	Outer surface guide
	KTV 162022 EG	12.7	16	20	22	11 400	15 700	Inner surface guide
18	KTV 182223.5 EG	14.9	18	22	■23.5	13 000	19 300	Inner surface guide
	KTV 182321 EG	16.4	18	23	21	14 400	18 900	Inner surface guide

